

Rigel Maxi 3p

Caratteristiche generali

nome	Rigel Maxi 3p
famiglia	Rigel
tipologia tipo	apparecchi da incasso
materiale struttura	Policarbonato
materiale diffusore	Policarbonato
configurazioni	Apparecchio da incasso per uso interno ed esterno





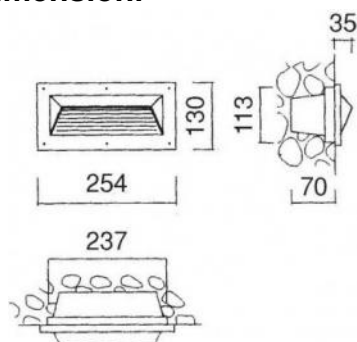



Dimensioni



Caratteristiche tecniche

IP 54 850° IK 10 20 J 

codice	colore diffusore	colore struttura	classe	classe e	lampada
3750 OP BI	 opale	 bianco	Classe I		 G23 2x7/9W
3750 OP NE	 opale	 nero			

Galleria immagini

